



IceBank[®]

THERMAL ENERGY STORAGE

DRAWING
Model 1190C3F
August 2007
CS-55

CALMAC Manufacturing Corp. 3-00 Banta Place Fair Lawn, NJ 07410 Tel (201) 797-1511 www.Calmac.com

Rigging Loops (2)

Allow 36"
(900 mm)
overhead
clearance
for service.

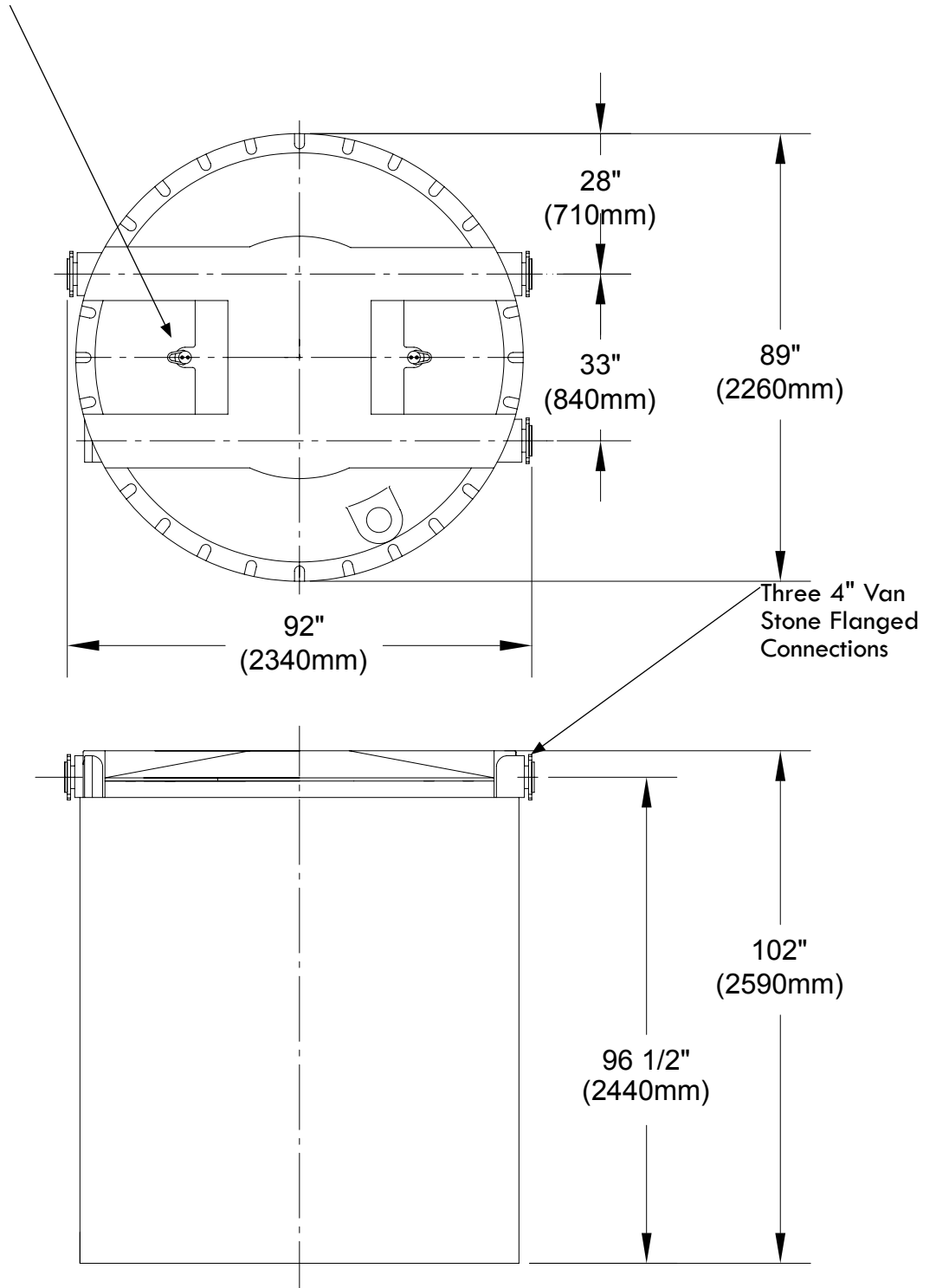

NOTE: Tolerance for all dimensions is $\pm 1/2"$ (12.5 mm)