



# IceBank<sup>®</sup>

THERMAL ENERGY STORAGE

**DRAWING**  
Model 1190C2F  
August 2007  
CS-54

CALMAC Manufacturing Corp. 3-00 Banta Place Fair Lawn, NJ 07410 Tel (201) 797-1511 www.Calmac.com

Rigging Loops (2)

Allow 36"  
(900 mm)  
overhead  
clearance  
for service.

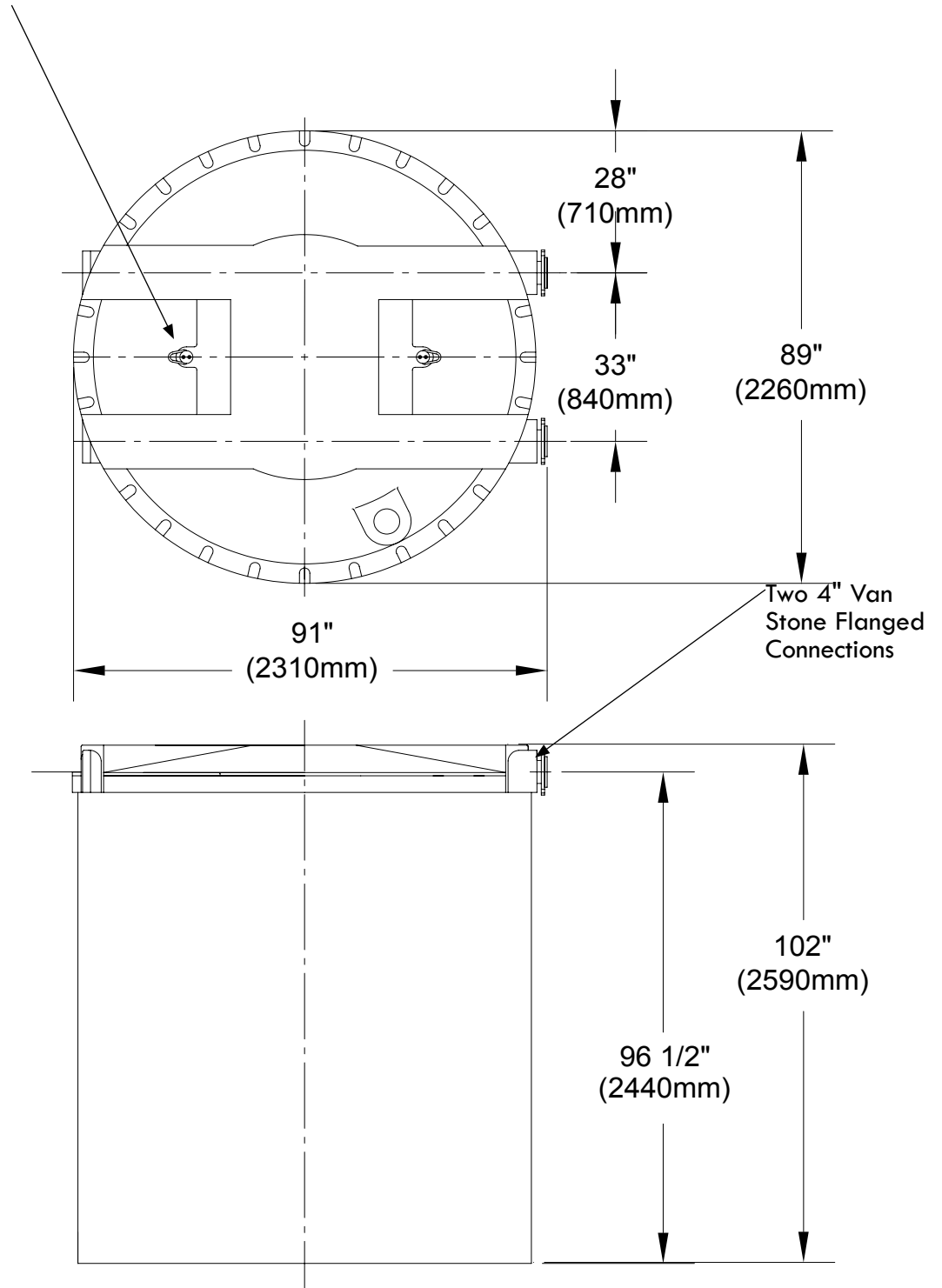

**NOTE:** Tolerance for all dimensions is  $\pm 1/2"$  (12.5 mm)